



Air operated diaphragm pumps

气动隔膜泵



上海民泉泵业有限公司

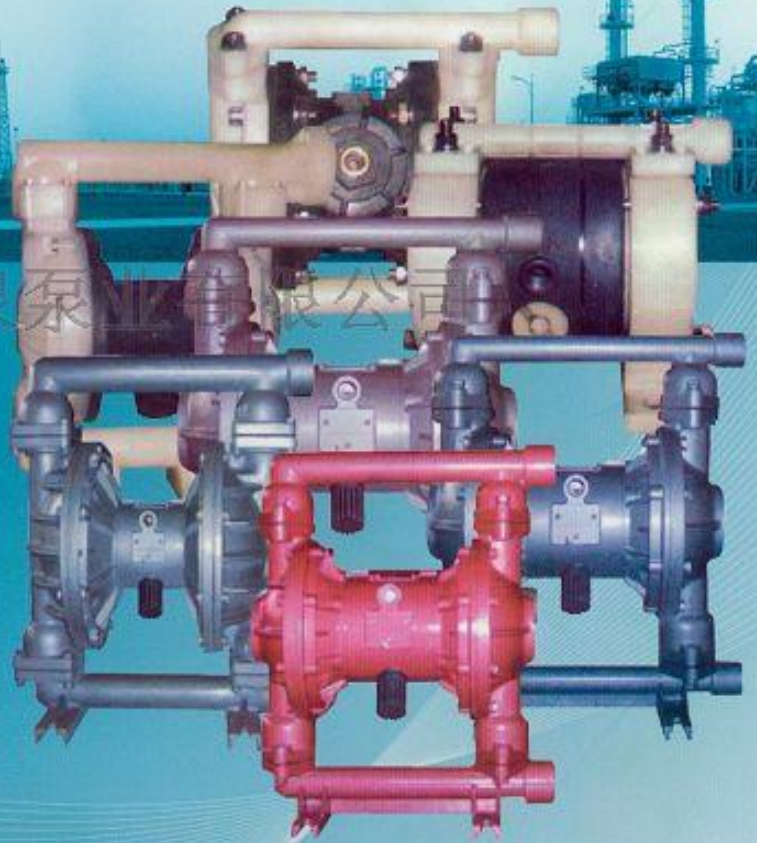

上海民泉泵业有限公司

地址：上海市交通西路48号 电话：021-36523279 13127808058



隔膜泵型号编制方法 Establishment method of pump model

泵型号由四个单元组成按下列顺序编制

The pump model is composed of four units and is established according to the following sequence

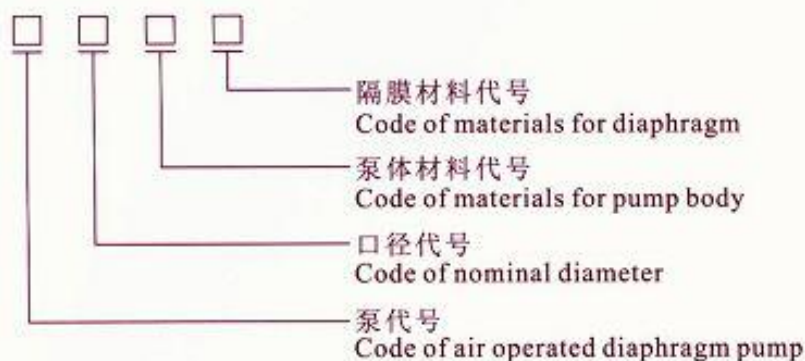

口径代号 Code of nominal diameter: 8(5/16), 10(3/8), 15(1/2), 25(1), 40(1¹/2), 50(2), 80(3)

泵体材料代号 Code of materials for pump body

泵体材料 Material of pump body	代号 Code	泵体材料 Material of pump body	代号 Code
铝合金 Aluminum alloy	L	不锈钢 Stainless steel	B
铸铁 Cast iron	Z	衬胶 Rubber lining	ZCJ
工程塑料 Engineering plastic	S		

隔膜材料代号 Code of materials for diaphragm

隔膜材料 Material of diaphragm	代号 Code	隔膜材料 Material of diaphragm	代号 Code
丁腈橡胶 Buna-N	NBR	氯丁橡胶 Neoprene	CR
氟橡胶 Viton	F	四氟橡胶 Teflon	F46
乙丙橡胶 Ethylene-propylene rubber	EPDM		

订货须知:

本公司QBK系列气动隔膜泵有两大系列,其中QBK1出口在中间, QBK2出口在侧边。订货时,要告之使用环境、温度、介质、流量、扬程、压力、泵体材料、隔膜材料。

Order notice:

We have two main series of QBK product, one is QBK1 which with center connection, the other is QBK2 with side connection. Please specify environment, temperature, medium, flow rate, head, pressure, materials of pump body and diaphragm when order.



产品概述 Performance summary

QBK气动隔膜泵是我公司开发的第三代气动隔膜泵，具有使用寿命长，不会停顿等优点，它既能抽送流动的液体，又能输送一些不易流动的介质，具有自吸泵、潜水泵、屏蔽泵、泥浆泵和杂质泵等输送机械的许多优点。

- 1、不需灌引水，吸程高达5m，扬程达70m，出口压力 $\geq 6\text{bar}$ 。
- 2、流动宽敞，通过性能好，允许通过最大颗粒直径达10mm。抽送泥浆、杂质时，对泵磨损甚微；
- 3、扬程、流量可通过气阀开度实现无级调节(气压调节在1-7bar之间)。
- 4、该泵无旋转部件，没有轴封，隔膜等抽送的介质与泵的运动部件、工件介质完全隔开，所输送的介质不会向外泄漏。所以抽送有毒、易挥发或腐蚀性介质时，不会造成环境污染和危害人身安全。
- 5、不必用电。在易燃、易爆场所使用安全可靠。
- 6、可以浸没在介质中工作。
- 7、使用方便、工作可靠、开停只需简单地打开和关闭气体阀门，即使由于意外情况而长时间无介质运行或突然停机，泵也不会因此而损坏。一旦超负荷，泵会自动地停机，具有自我保护性能，当负荷恢复正常后，又能自动启动运行。
- 8、结构简单、易损件少，该泵结构简单，安装、维修方便，泵输送的介质不会接触到配气阀，联杆等运动部件，不象其他类型的泵因转子、活塞、齿轮、叶片等部件的磨损而使性能逐步下降。
- 9、可输送较粘的液体(粘度在1万厘泊以下)。
- 10、本泵无须用油润滑，即使空转，对泵也无任何影响，这是该泵最大特点。

上海民泉泵业有限公司

QBK is coosai's new developed series of AODD pump which is also the third generation, it has the virtue of long service life and nonstop operation, not only it can convey some uneasy flowed medium, with the merits the merits of self-pumping pump, diving pump, shield pump, slurry pump and impurity pump etc.

- 1.It's unnecessary to pour the drawing water, the suction lift reaches 5m height, the delivery lift reaches 70m length.
- 2.Wide flow and good performance. The diameter allowed to pass the max grain reaches 10mm. The damage is very less to the pump while exhausting the slurry and impurity.
- 3.The delivery lift and flow can pass the pneumatic valve open to realize the step less adjustment(the pneumatic pressure adjust ment is between 1-7bar).
- 4.This pump has no rotary parts and no bearing seals. The diaphragm will completely separate the exhausted medium and pump running parts, working medium. The conveyed medium can't be leaked outside. Thus it will not cause the environmental pollution and human body safety dangerous while exhausting the toxin and flammable or corrosive medium.
- 5.No electricity. It's safe and reliable while using in the flammable and explore places.
- 6.It can be soaked in medium.
- 7.It's convenient to use and reliable to work. Only open or close the gas valve body while starting or stopping. Even if no medium operation or pausing suddenly for long time because of accident matters, the pump will not be damaged caused by this. Once over loading, the pump will automatically stop and possesses the self protection function. When the load recovers normally, it also can start automatically.
- 8.Simple structure and less wearing parts. This pump is simple in structure, installation and maintenance. The medium conveyed by the pump will not touch the matched pneumatic valve and coupling lever etc. Not like other kinds pumps, the performance will drop down gradually because of the damages of rotor, gear and vane etc.
- 9.It can transmit the adhesive liquid(the viscosity is below 10000 centipoises).
- 10.This pump needn't the oil lubricant. Even if idling, it has any influence to the pump. This is a characteristic of this pump.



Air operated diaphragm pumps 气动隔膜泵

性能曲线图 Performance graph



QBK-8

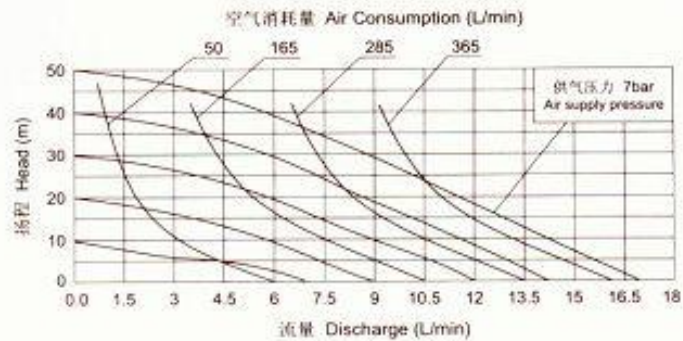

QBK-15

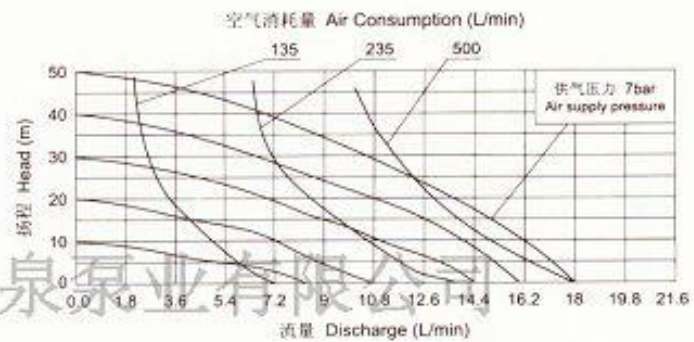

QBK-25

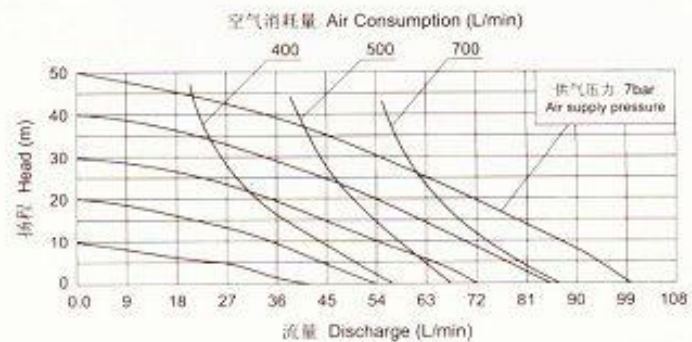

QBK-40

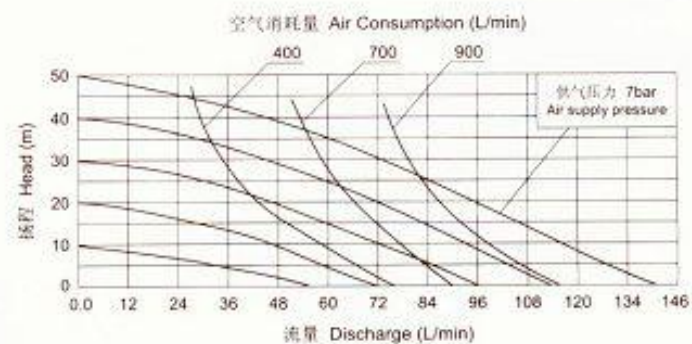



Air operated diaphragm pumps 气动隔膜泵

性能曲线图 Performance graph



QBK-50

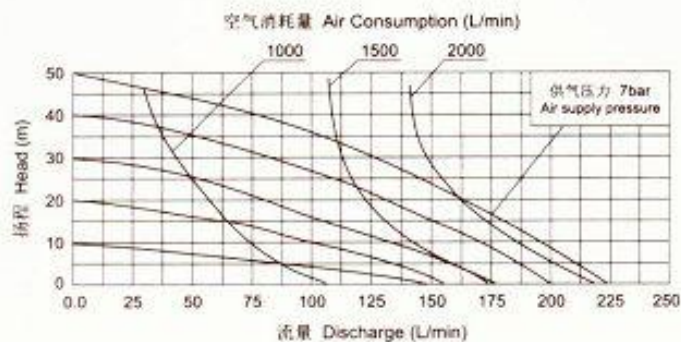

QBK-65

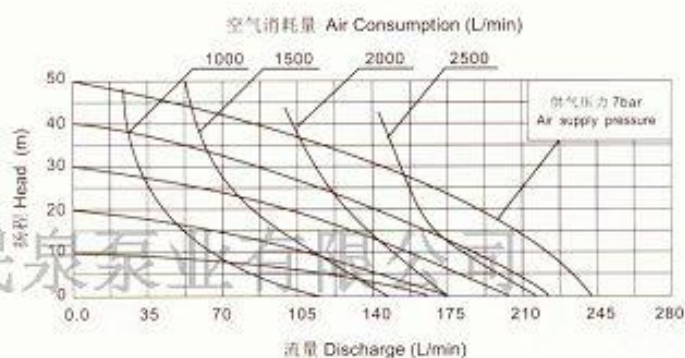

QBK-80

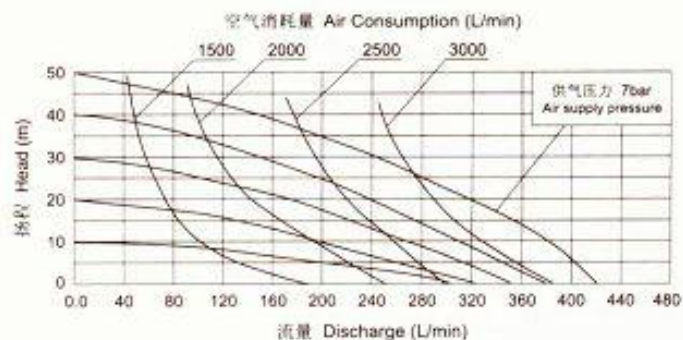

QBK-100

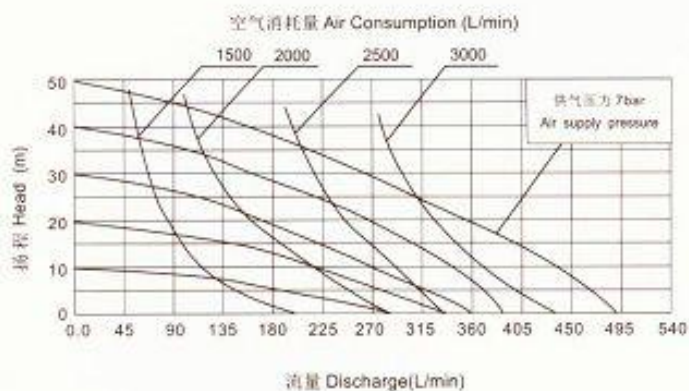



规格一览表 General specification

型号 Type	入口 Suction		出口 Discharge		连接方式 Type of Connection				泵体材质 Material of pump body				
	inc	mm	inc	mm	NPT	BSPT	ANSI 法兰 Flanged	DIN 法兰 Flanged	铸铁 Cast iron Z	铝合金 Aluminum alloy L	不锈钢 Stainless steel B	塑料 Engineering plastic S	衬胶 Rubber lining ZCJ
QBK-8	5/16	8	5/16	8	●	●	-	-	-	-	-	●	-
QBK-10	3/8	10	3/8	10	●	●	-	-	●	●	●	●	-
QBK-15	1/2	15	1/2	15	●	●	-	-	●	●	●	●	-
QBK-25	1	25	1	25	●	●	-	-	●	●	●	●	-
QBK-40	1 1/2	40	1 1/2	40	●	●	-	-	●	●	●	●	-
QBK-50	2	50	2	50	●	●	●	●	●	●	●	●	-
QBK-65	2 1/2	65	2 1/2	65	●	●	●	●	●	●	●	-	●
QBK-80	3	80	3	80	●	●	●	●	●	●	●	-	-
QBK-100	4	100	4	100	-	-	●	●	●	●	●	-	●

主要零件材料 Major parts material form

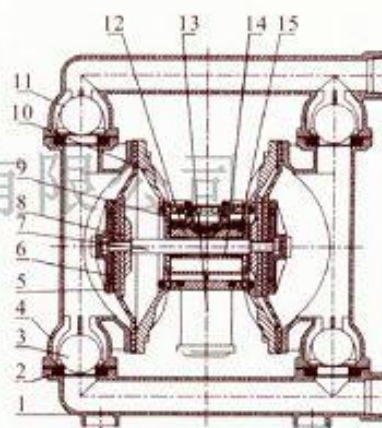

QBK系列气动隔膜泵 QBK Air operated diaphragm pump							
序号 No	零件名称 Accessory name	数量 Amount	材料 Material				
1	下盖 Bottom	1	不锈钢 Stainless steel 1Cr18Ni9Ti	铝合金 Aluminum alloy ZL104	铸铁 Cast iron HT200	塑料 Engineering plastic	
2	球座 Tee	4	氟丁 Neoprene	丁腈 Buna-N	四氟 Teflon	氟橡胶 Viton	
3	球芯 Ball	4	氟丁 Neoprene	丁腈 Buna-N	四氟 Teflon	陶瓷 Argil	
4	立柱 Stand column	2	不锈钢 Stainless steel 1Cr18Ni9Ti	铝合金 Aluminum alloy ZL104	铸铁 Cast iron HT200	塑料 Engineering plastic	
5	隔膜 Diaphragm	2	氟丁 Neoprene	丁腈 Buna-N	四氟 Teflon	氟橡胶 Viton	
6	隔膜外压板 Outside platen	2	组件 Subassembly				
7	中间轴 Shaft	1	不锈钢 Stainless steel 1Cr18Ni9Ti				
8	隔膜内压板 Endo platen	2	Q235-A				
9	中间体垫 Block Gasket	2	丁腈 Buna-N				
10	隔膜排 Clapboard	2	铝合金 Aluminum alloy ZL104				
11	上盖 Top	1	不锈钢 Stainless steel 1Cr18Ni9Ti	铝合金 Aluminum alloy ZL104	铸铁 Cast iron HT200	塑料 Engineering plastic	
12	中间体组件 Center pump body	1	组件 Subassembly				
13	消声器 Muffler	1	ABS				
14	U型密封圈 U Ring	4	丁腈 Buna-N				
15	中间轴导向套 Guide sleeve	1	组件 Subassembly				



主要外形尺寸表 Tables of setting data

型号 Type	A	B	C	D	E	H1	H2	H3	H	螺纹 Threaded	法兰式 Flanged	
										NPT/BSPT	ANSI	DIN
QBK-8	97	82	147	115	7	20	110.5	10	143	5/16"	-	-
QBK-10	135	48	218	144	12	34	176	10	226	3/8"-1/2"	-	-
QBK-15	135	48	218	144	12	34	176	10	226	3/8"-1/2"	-	-
QBK-25	236	145	381	248	12	46	344	18	412	1"	-	-
QBK-40	236	145	381	248	12	50	348	18	428	1 1/2"	-	-
QBK-50	320	220	518	347	14	50	521	27	609	2"	●	●
QBK-65	320	220	494	347	14	99	526.4	50	718	2 1/2"	●	●
QBK-80	360	240	634	455	18	96	696	50	842	3"	●	●
QBK-100	360	240	574	455	18	120	719	50	953.5	-	●	●

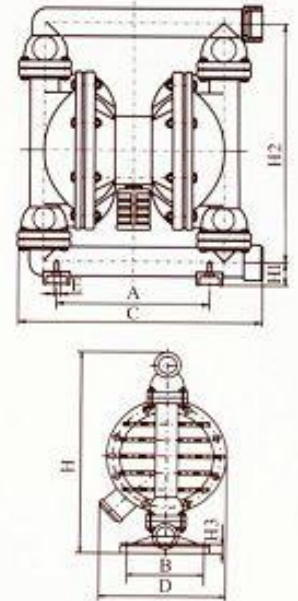

法兰端尺寸根据相应的标准设计，按设计规定，也可以根据客户的设计生产。

The dimension for the flange is designed in accordance with the relevant standard, and it can be specified as the customers' requirement.

主要技术参数 Main specifications

型号 Type	最大流量 Max Flow Rate (L/Min)	出口压力 (最大) Discharge Pressure (Bar)	吸程 Sucked Lift (m)	最大允许 颗粒直径 Max Grain Diameter (mm)	最大空气 消耗量 Max Air Consumption (L/min)	隔膜材质 Material Of Diaphragm				
						丁腈 橡胶 Buna-N	氯丁 橡胶 Neoprene	乙丙 橡胶 EPDM	氟橡胶 Viton	四氟 Teflon
QBK-8	16	6.9	5	1	300	●	●	●	●	●
QBK-10	20	6.9	5	1	300	●	●	●	●	●
QBK-15	20	6.9	5	1	300	●	●	●	●	●
QBK-25	100	6.9	5	2.5	600	●	●	●	●	●
QBK-40	140	6.9	5	4.5	600	●	●	●	●	●
QBK-50	240	6.9	5	8	900	●	●	●	●	●
QBK-65	280	6.9	5	8	900	●	●	●	●	●
QBK-80	400	6.9	5	10	1500	●	●	●	●	●
QBK-100	480	6.9	5	10	1500	●	●	●	●	●

系统连接示意图 System connection schematic diagram

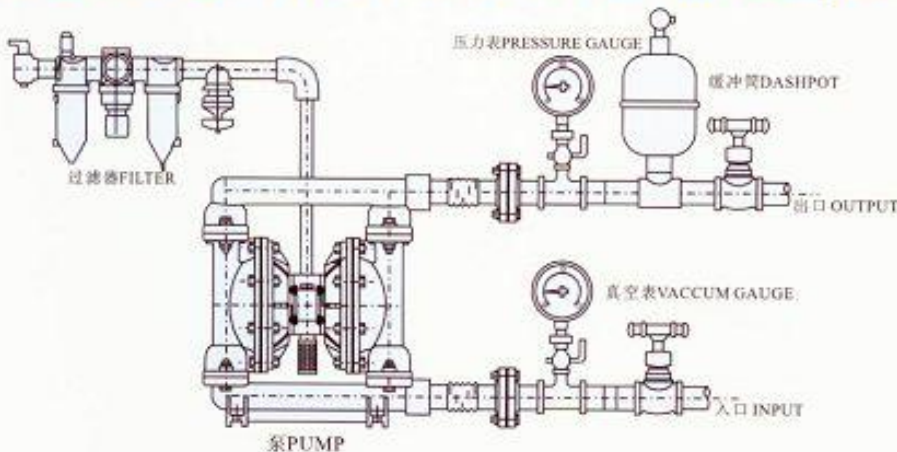

备注：在使用QBK气动隔膜泵时，要安装空气过滤器，以滤去压缩空气中的水分，并在泵的出口安装压力表，避免因压力过高损害泵，在泵不工作时应及时清洗泵，避免因凝固损坏泵。

Note: When the air operated diaphragm pump works, install the air filter to leach the moisture from the compressed air, and install the manometer at the outlet of pump, so to avoid damaging as too high pressure, when the pump doesn't need work, please clean it in time to prevent from concreting.